



6+



2



1,4m



1 = 30m 2 = 3,41m 3 = 4,3m

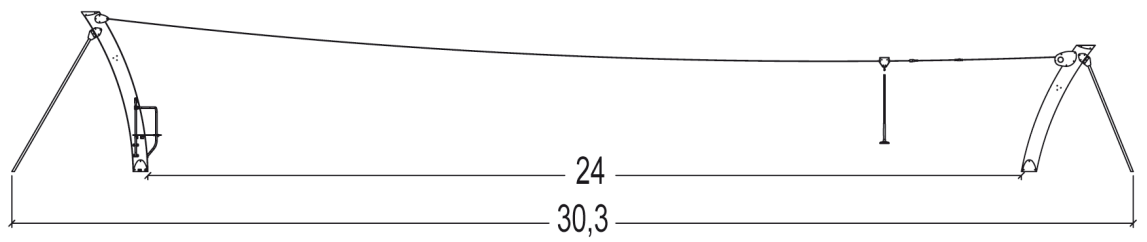
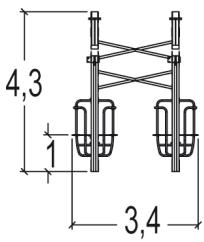
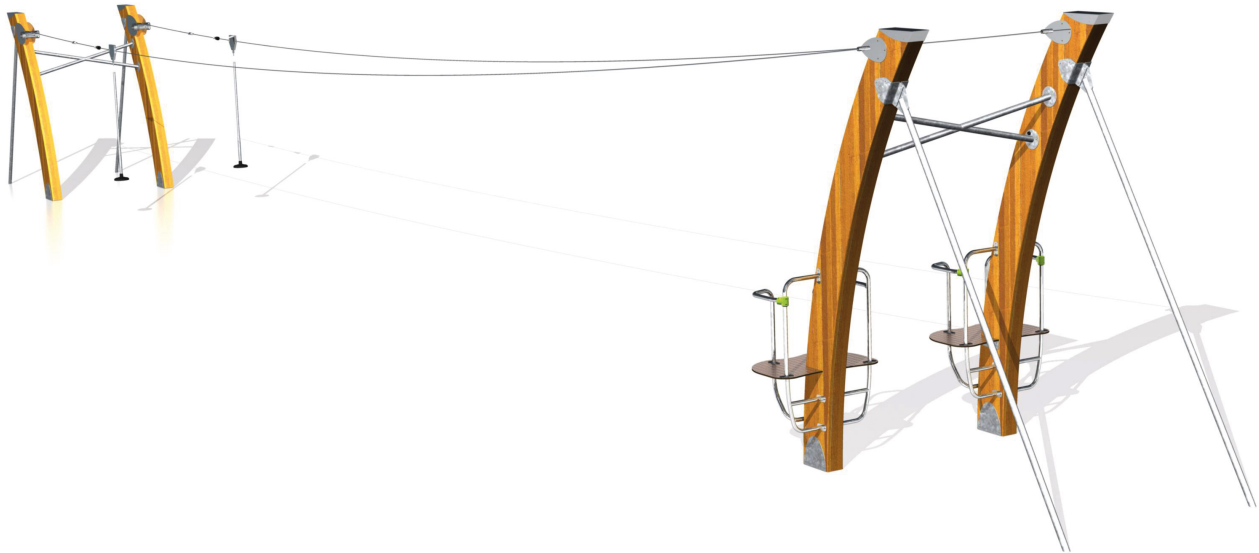

Play value : 3

meeting



sliding



getting across







## Installation of equipment

Impact area =

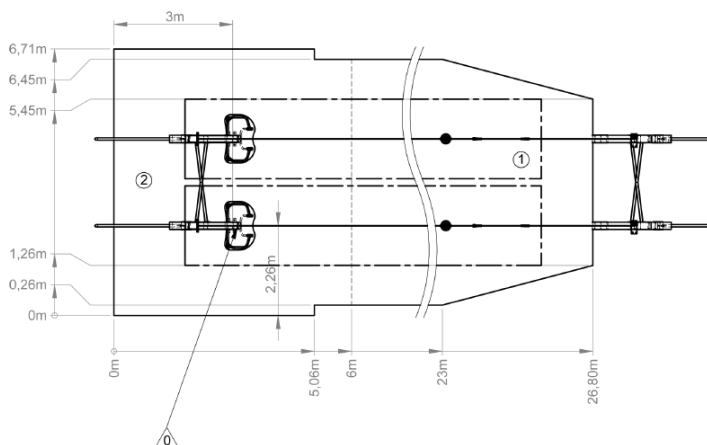
-  Impact area
-  Free space



		
1	1m	124,9m <sup>2</sup>
2	1,4m	39,8m <sup>2</sup>



2



20h00



5.6m<sup>3</sup>



165m<sup>2</sup>



1353kg



193kg

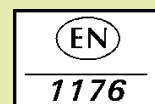

*Proludic*

0000-00-00