



2+



10



0,6m



1 = 2,3m 2 = 1,4m 3 = 1,9m



Motor disability  
Sensorial disabilities  
Learning disabilities

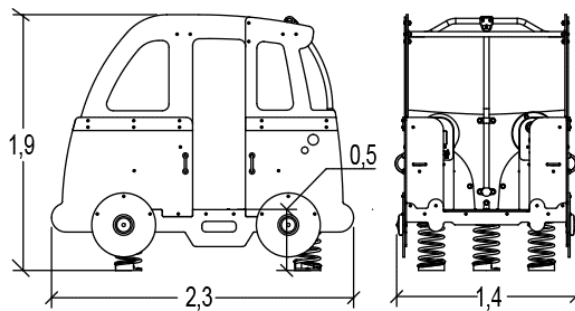
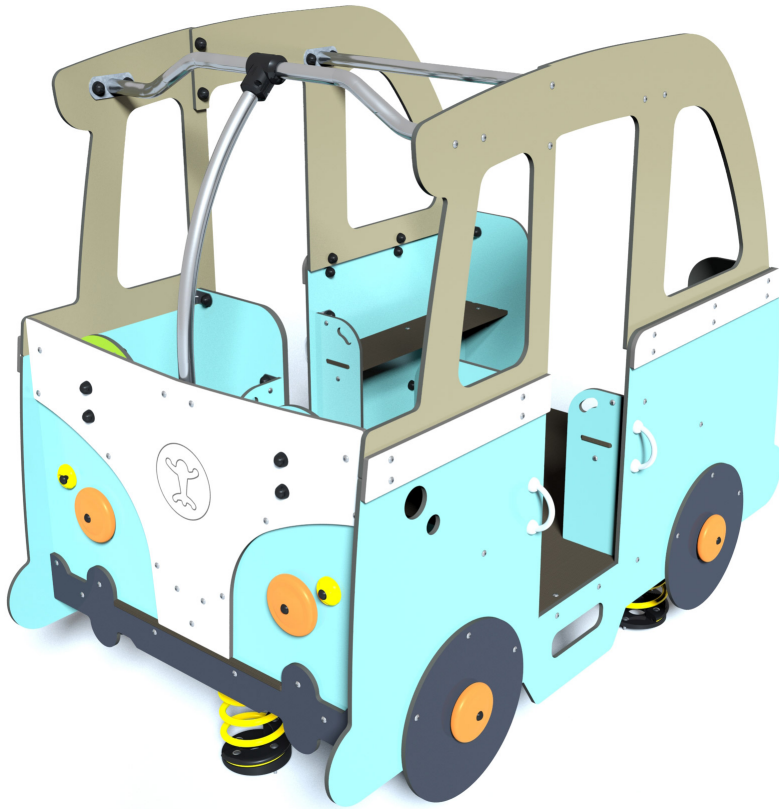
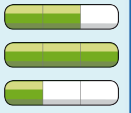

Play value : 7

resting



meeting



role play



balancing



thinking



handling



tactile stimulation



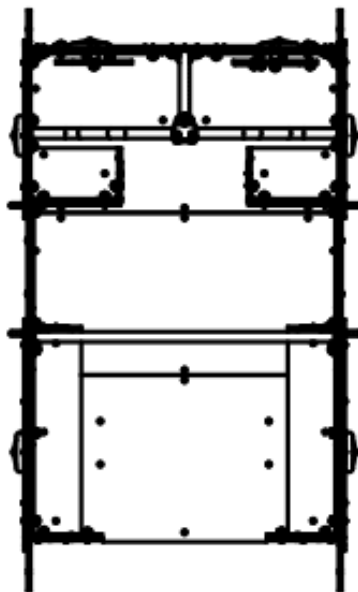



## Installation of equipment

Impact area =

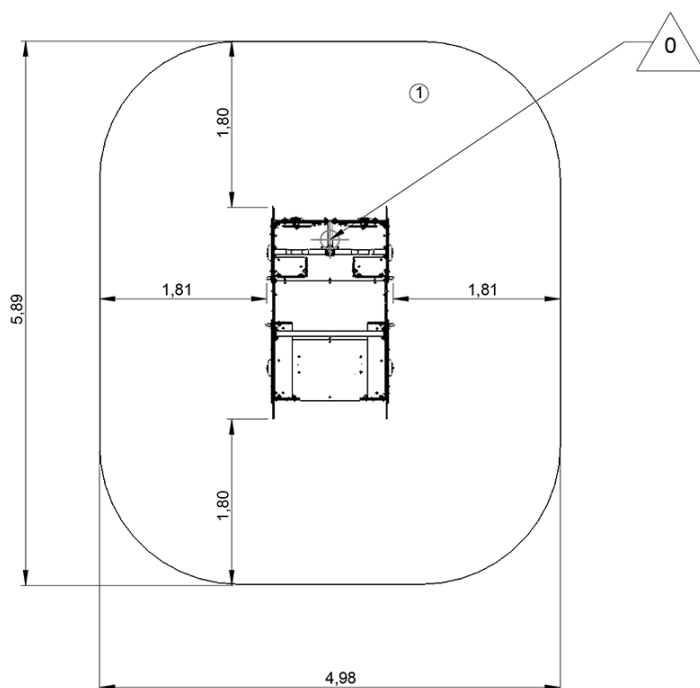
 Impact area  
 Free space



		
1	0,6m	27,5m <sup>2</sup>



2



05h00



0m<sup>3</sup>



27.5m<sup>2</sup>



313kg



13kg

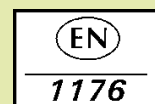

*Proludic*

0000-00-00